

Turbina integramente en inox 304
Impeller full made in stainless steel 304
Turbine entièrement inoxydable 304

 **Bombas multicelulares.**

Aplicaciones: Las bombas horizontales multicelulares de la serie SIGMA, por su elevado rendimiento y funcionamiento EXTREMADAMENTE SILENCIOSO, son especialmente indicadas para su uso en equipos de presurización tanto de uso domestico como industriales.

Autoaspirantes hasta 2 mts.

Características Constructivas: Turbinas y cuerpo bomba en acero inoxidable AISI 304. Difusores en tecnopolímero inyectado con fibra de vidrio. Cuerpo de aspiración e impulsión en fundición GG-20, pintado interior y exteriormente con pintura antioxidante mediante cataforesis. Eje en acero inoxidable AISI 431. Cierre mecánico en cerámica grafito y AISI 304. Ø Rosca de asp/imp:

- Series 100/200: 1"
- Series 300/400: 1 1/4"

Motor: Motor asíncrono, cerrado de ventilación externa, apto para trabajo continuo. Grado de protección IP-55, aislamiento clase F (calentamiento "B") aptos para trabajo a través de variadores de frecuencia.

Temperatura máxima del agua: 35°C.
Temperatura máxima ambiente: 45°C.

 **Multistage pumps.**

Applications: The multistage horizontal pumps of the SIGMA series, through their high output and extremely silent operation, are particularly recommended for the use in domestic and industrial pressuring systems.
 Self priming up to 2 meters.

Constructive characteristics: Impeller and pump housing in stainless steel AISI 304. Shaft in stainless steel AISI 420. Diffusers injected with fiber glass. Inlet and outlet body in cast iron GG-20 with internal and external rust proofing paint. Mechanical seal in graphite ceramic and Stainless steel AISI 431.

- Ø Connection Inlet/outlet:
- 100/200 series: 1"
 - 300/400 series: 1 1/4"

Motor: Standard asynchronous motor, sealed from external ventilation, suitable for continuous work. IP-55 protection, class F Isolation B. Suitable for work through frequency inverters.

Maximum water temperature: 35°C.
Maximum ambient temperature: 45°C.

 **Pompes multicellulaires.**

Applications: Les pompes verticales multicellulaires de la serie SIGMA étant très performantes et extrêmement silencieuses, sont spécialement indiquées pour être utilisées sur des équipements de pressurisation pour un usage civil qu'industriel.
 Pompe auto-aspirante jusqu'à 2 mètres.

Caractéristiques Constructives: Turbinas et corps pompe en acier inoxydable AISI 304. Arbre pompe en acier inoxydable AISI 420. Diffuseurs en techno polymère injecté avec fibre de verre. Corps aspiration et corps impulsión en fonte GG-20 avec traitement antioxydant intérieur et extérieur. Fermeture mécanique en céramique graphite et AISI 431.

- Ø Connexion Aspiration/Impulsion:
- Series 100/200: 1"
 - Series 300/400: 1 1/4"

Moteur: Moteur asynchrone standard, fermé à ventilation externe, apte à un travail continu. Degré de protection IP-55, Isolement classe F (chauffage B) apte à un fonctionnement à travers de variateurs de fréquence.

Température maximale de l'eau : 35°C.
Température ambiante maximale : 45°C

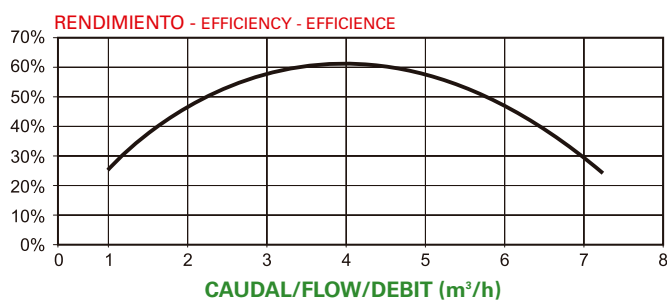
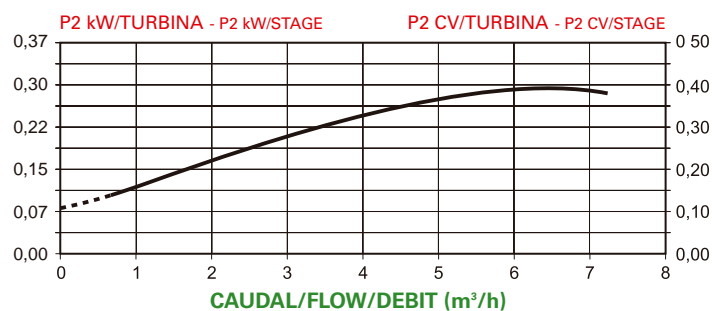
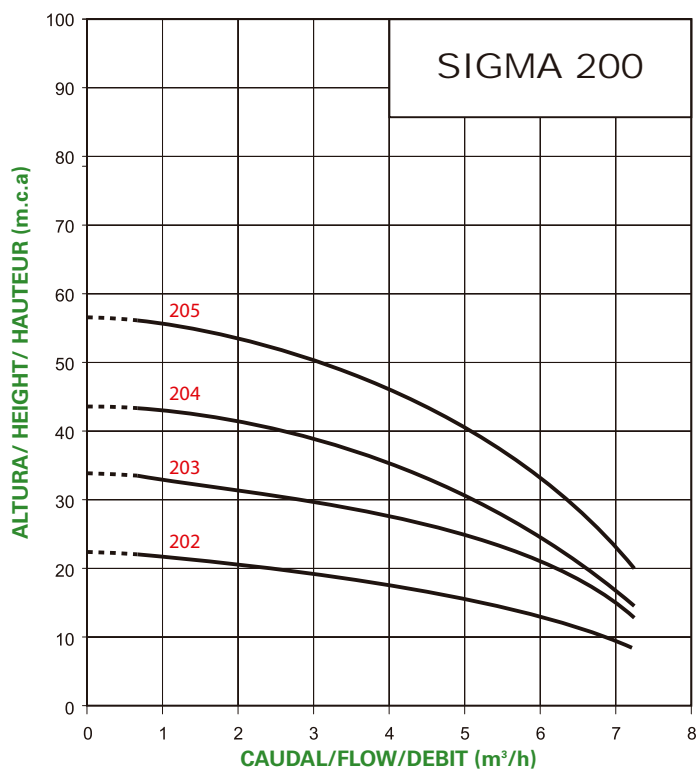
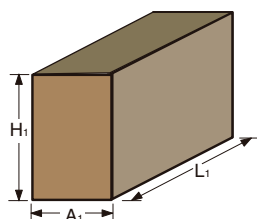
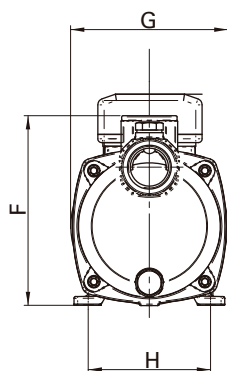
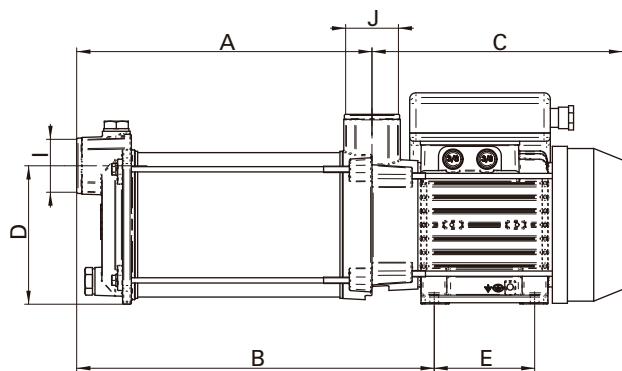

Tipo / Type	A	B	C	D	E	F	G	H	I	J	H ₁	A ₁	L ₁	Neto Kg	Bruto Kg
SIGMA 202	198	205	225	127	81	183	132	112	1"	1"	186	138	477	13,1	13,9
SIGMA 203	198	205	225	127	81	183	132	112	1"	1"	186	138	477	13,7	14,5
SIGMA 204	224	231	225	127	81	183	132	112	1"	1"	186	138	477	14,8	15,6
SIGMA 205	250	257	225	127	81	183	132	112	1"	1"	186	138	477	17,5	18,3

Tipo Type	Potencia		"A"			Cond. µf	Caudal m³/h / Flow m³/h							Diámetro		
	HP	KW	II	III	III		0	1	2	3	4	5	6	7	ASP.	IMP.
			230	230	400											
SIGMA 202	1	0,75	4,7	-	-	12	23	22	21	20	18	16	13	9	1"	1"
SIGMA 203	1	0,75	5,5	-	-	12	34	33	32	30	27,5	24	19	13	1"	1"
SIGMA 204	1,25	0,42	6,8	-	-	20	44	43	41,5	39	35,5	30,5	24	16,5	1"	1"
SIGMA 205	1,5	1,1	7,4	5,2	3	20	57	56	54	51	46,5	40	32	22	1"	1"